

Touch-it XELO Open Frame glass 12,1

Datasheet



- **Made in Germany**
- **Multitouch**
- **24h/7d – Industrial Grade**
- **Fanless**
- **Long Term Availability**

PANEL

LCD Size	12.1 inch (30.7 cm)
Resolution	1280 x 800
Aspect Ratio	16 : 10
Technology	TFT
Colours	16.2M
Backlight	LED
Backlight Life Time	50,000 h
Luminance*	400 cd/m ²
Contrast Ratio*	800 : 1
Viewing Angle* (right/left/up/down)	80°/80°/65°/80°
Touch	Projected Capacitive Touch, Anti-Glare, Multitouch (not supported in WS7E)

*The values are referring to the displays only.

SYSTEM

CPU	AMD® GX-415GA Quad Core™ 1.5 GHz 64 Bit, 2 MB Cache	Intel® Core™ i5-5350U Dual Core 1.8 GHz 64 Bit, 3 MB Cache
Chipset	Integrated in APU	Integrated in Intel® 5th Gen. Core™ i U-series
Graphic	Radeon HD 8330E 500 MHz	Intel® HD Graphics 6000 300 MHz
Memory	4 GB DDR3L / 8 GB DDR3L / 16 GB DDR3L (i5 only)	
Storage	32 / 64 / 128 / 256 / 512 GB MLC SSD / up to 1TB HDD	
BIOS	AMI BIOS, Supports ACPI Function	
Wake on LAN	Yes	
H/W Status Monitoring	Supports Power Supply Voltages and Temperature Monitoring	
CMOS Battery	Lithium Battery	
Operating System	Windows® Embedded Standard 7 (WS7P) Windows® Embedded Standard 7 (WS7E) Windows® Embedded 8 Standard Windows® 10 IoT Linux	

Touch-it XELO Open Frame glass 12,1

Datasheet

STANDARD INTERFACES

USB	2 x USB Host 3.0 (Type A)
Ethernet	2 x 1 Gbit Ethernet
Communication	1 x RS-232 / RS-422 / RS-485 (BIOS setting)
Video	1 x DVI-I

OPTIONAL INTERFACES

USB	4 x USB Host 2.0 (Type A, max. Total Current 0.5 A)
WLAN	1 x 802.11 ac/a/b/g/n (2.4 GHz, 5 GHz)

POWER SUPPLY

Supply Voltage	24 VDC \pm 20%	
Power Consumption (nom/max*)	AMD® Quad Core: 13 W / 28 W	Intel® Core™ i5 5 th Gen: 16 W / 37 W
Power Connector	Phoenix 3-pol MC 1,5/ 3-STF-3,5 BK (screwable) / Phoenix 3-pol MC 1,5/ 3-ST-3,5 BK	

*max. periphery consumption included (e.g. 1xUSB 2.0 equals 2.5W)

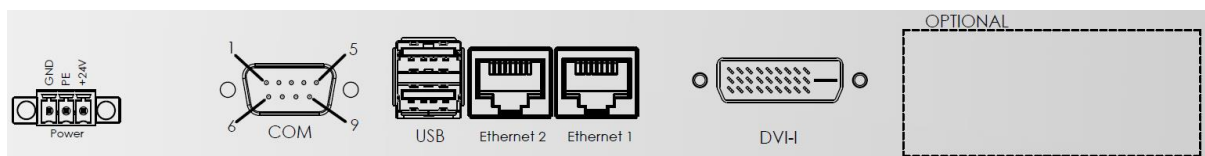

INTERFACES

PIN	Signal Name		
	RS-232	RS-422	RS-485
	DCD	TX-	DATA-
1	RX	TX+	DATA+
2	TX	RX+	NC
3	DTR	RX-	NC
4	Ground	Ground	Ground
5	DSR	NC	NC
6	RTS	NC	NC
7	CTS	NC	NC
8	RI	NC	NC
9			

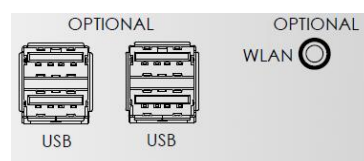

Touch-it XELO Open Frame glass 12,1

Datasheet

MECHANICAL & ENVIRONMENTAL

Housing Front	Glass, without Frame
Housing	Metallic Cover
Dimensions	308.5 ± 0.2 mm x 210.4 ± 0.2 mm x 58.3 mm
Weight	2.0 kg
Cooling	Passive
Operating Temperature	0 ~ 50 °C
Storage Temperature	-10 ~ 70 °C
Humidity	5 ~ 80% (non condensing)
Protection Class	IP65 (IP20 rear)
Certification	CE, EN55032 Class A, EN55024

Never cover the Touch-it XELO Open Frame glass 12,1 completely or build it in a small closed and unvented housing.

Touch-it XELO Open Frame glass 12,1

Datasheet

DIMENSIONS

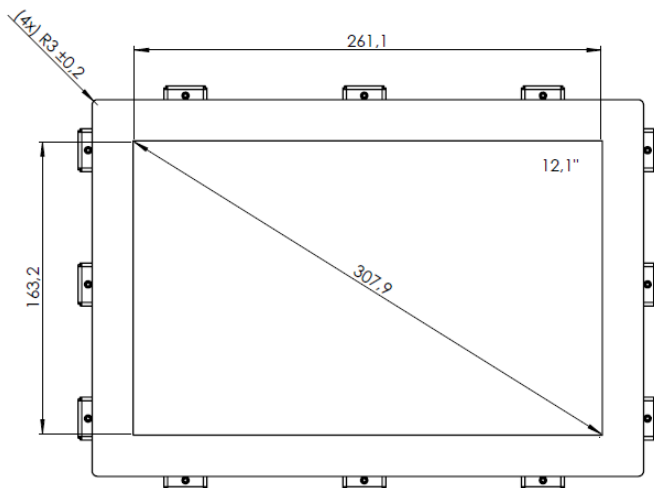

FRONT VIEW

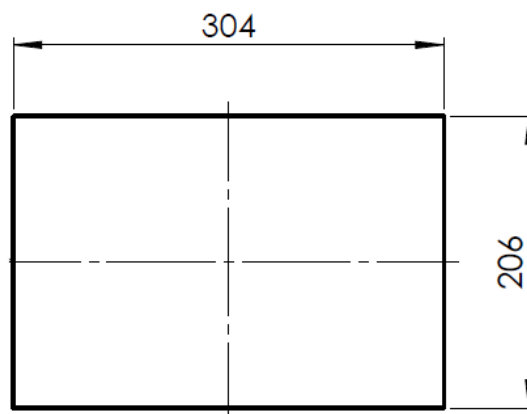

cut-out - counterplate

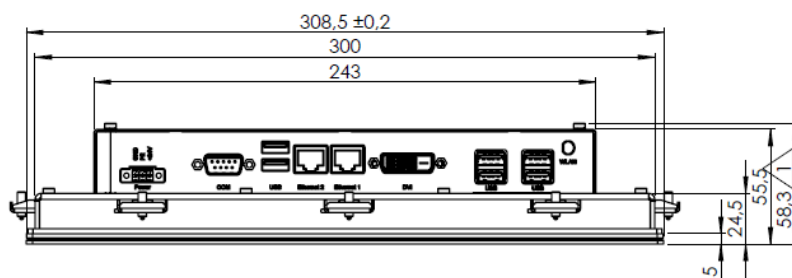

BOTTOM VIEW

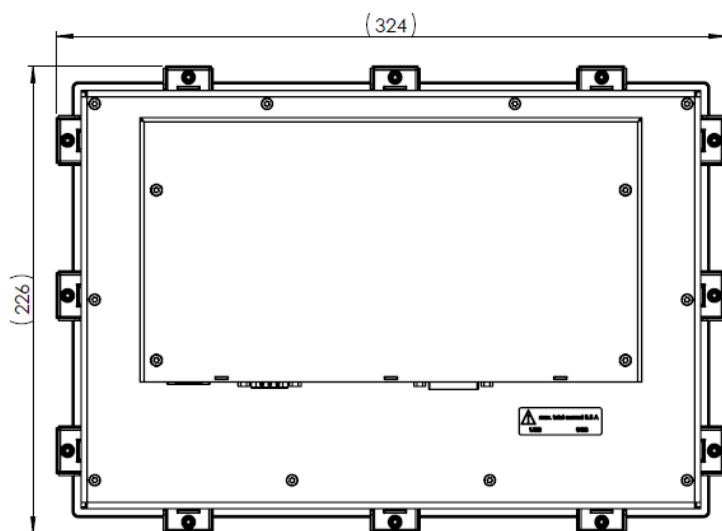

REAR VIEW

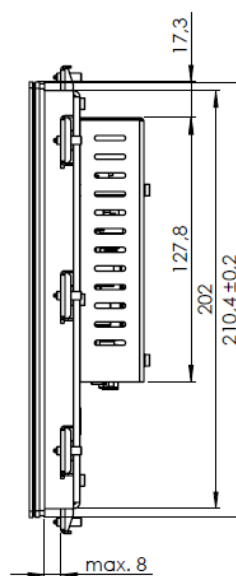

SIDE VIEW

Touch-it XELO Open Frame glass 12,1

Datasheet

ORDERING INFORMATION

Art. No.:	CPU		RAM			Storage						Optional Interfaces	
	AMD Quad-Core	Intel i5 5 th Gen.	4 GB	8 GB	16 GB (i5 only)	32 GB SSD	64 GB SSD	128 GB SSD	256 GB SSD	512 GB SSD	500 GB HDD	4 x USB	WLAN
E741203	<input checked="" type="checkbox"/>	<input type="checkbox"/>	<input checked="" type="checkbox"/>	<input type="checkbox"/>	<input type="checkbox"/>	<input checked="" type="checkbox"/>	<input type="checkbox"/>	<input type="checkbox"/>	<input type="checkbox"/>	<input type="checkbox"/>	<input type="checkbox"/>	<input type="checkbox"/>	<input type="checkbox"/>
E741231	<input type="checkbox"/>	<input checked="" type="checkbox"/>	<input type="checkbox"/>	<input checked="" type="checkbox"/>	<input type="checkbox"/>	<input type="checkbox"/>	<input type="checkbox"/>	<input checked="" type="checkbox"/>	<input type="checkbox"/>	<input type="checkbox"/>	<input checked="" type="checkbox"/>	<input checked="" type="checkbox"/>	<input type="checkbox"/>
E741239	<input type="checkbox"/>	<input checked="" type="checkbox"/>	<input checked="" type="checkbox"/>	<input type="checkbox"/>	<input type="checkbox"/>	<input checked="" type="checkbox"/>	<input type="checkbox"/>	<input type="checkbox"/>	<input type="checkbox"/>	<input type="checkbox"/>	<input type="checkbox"/>	<input type="checkbox"/>	<input type="checkbox"/>

DISCLAIMER

Technical data are subject to modification and delivery subject to availability. Any liability that the data and illustrations are complete, actual or correct is excluded. Designations may be trademarks and/or copyrights of the respective manufacturer, the use of which by third parties for their own purposes may infringe the rights of such owner.

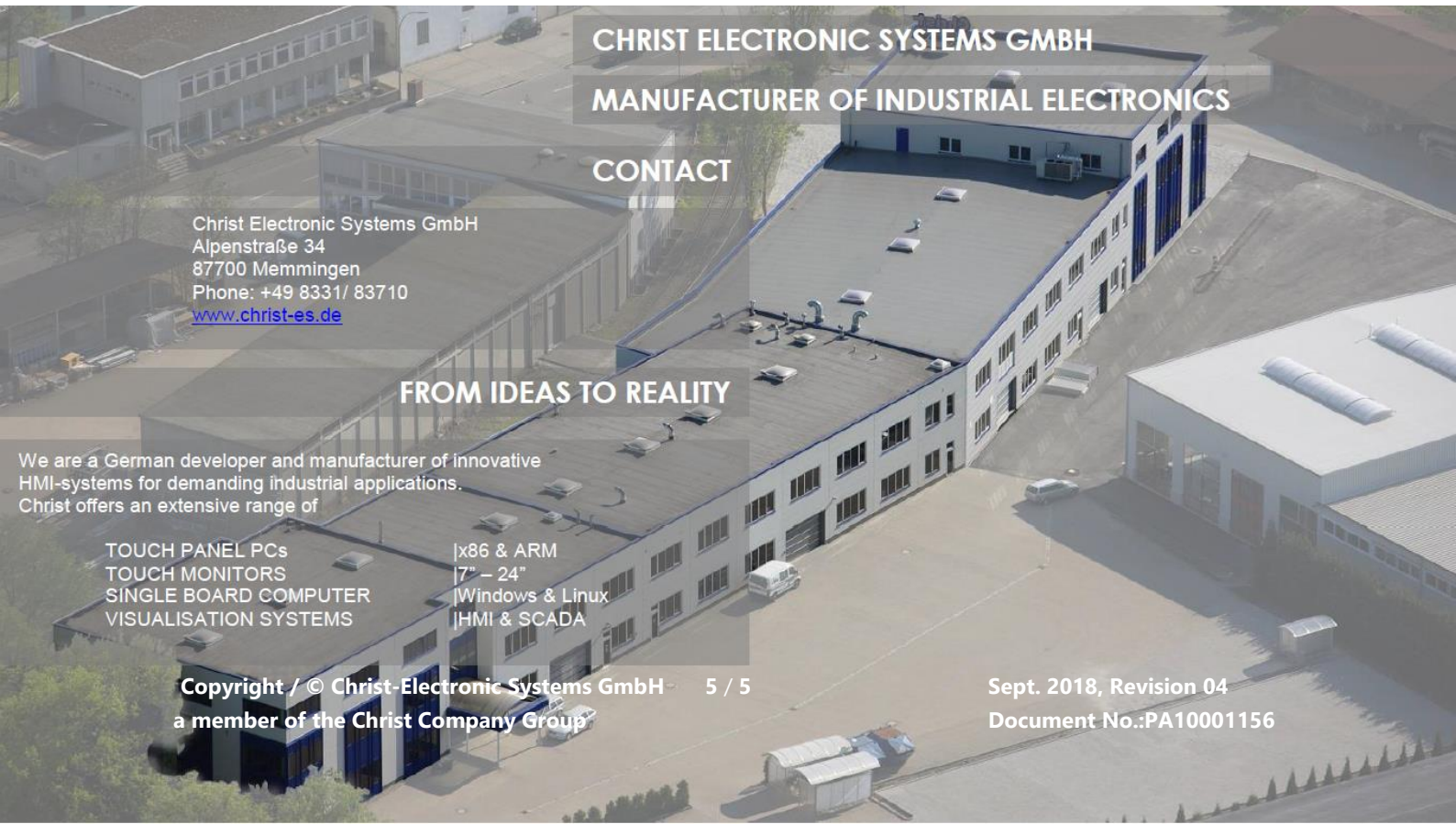

CHRIST ELECTRONIC SYSTEMS GMBH
MANUFACTURER OF INDUSTRIAL ELECTRONICS

CONTACT

Christ Electronic Systems GmbH
 Alpenstraße 34
 87700 Memmingen
 Phone: +49 8331/ 83710
www.christ-es.de

FROM IDEAS TO REALITY

We are a German developer and manufacturer of innovative HMI-systems for demanding industrial applications. Christ offers an extensive range of

TOUCH PANEL PCs
 TOUCH MONITORS
 SINGLE BOARD COMPUTER
 VISUALISATION SYSTEMS

|x86 & ARM
 |7" – 24"
 |Windows & Linux
 |HMI & SCADA