

# Touch-it Monitor Front Panel glass 10,4

## Datasheet

- **Made in Germany**
- **Multitouch**
- **24h/7d – Industrial Grade**
- **Fanless**
- **Long Term Availability**

### PANEL

<b>LCD Size</b>	10.4 inch (26.4 cm)	
<b>Resolution</b>	800 x 600	1024 x 768
<b>Aspect Ratio</b>	4 : 3	
<b>Technology</b>	TFT	
<b>Colours</b>	16.2M	
<b>Backlight</b>	LED	
<b>Backlight Life Time</b>	30,000 h	30,000 h
<b>Luminance*</b>	230 cd/m <sup>2</sup>	350 cd/m <sup>2</sup>
<b>Contrast Ratio*</b>	500 : 1	1200 : 1
<b>Viewing Angle* (right/left/up/down)</b>	80°/80°/60°/70°	88°/88°/88°/88°
<b>Touch</b>	Projected Capacitive Touch, Anti-Glare, Multitouch	

\*The values are referring to the displays only.

### STANDARD INTERFACES

<b>USB</b>	1 x USB Device (Type B, Touch-Control) 2 x USB Host 2.0 (Type A)
<b>Video</b>	1 x DVI-D 1 x HDMI

### OPTIONAL INTERFACES

<b>USB</b>	4 x USB Host 2.0 (Type A, max. Total Current 0.5 A)
------------	---

# Touch-it Monitor Front Panel glass 10,4

## Datasheet

### POWER SUPPLY

<b>Supply Voltage</b>	24 VDC $\pm$ 20%	
<b>Power Consumption (max)</b>	12 W	13 W
<b>Power Connector</b>	Phoenix 3-pol MC 1,5/ 3-STF-3,5 BK (screwable) / Phoenix 3-pol MC 1,5/ 3-ST-3,5 BK	

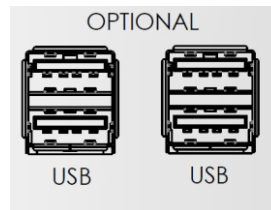
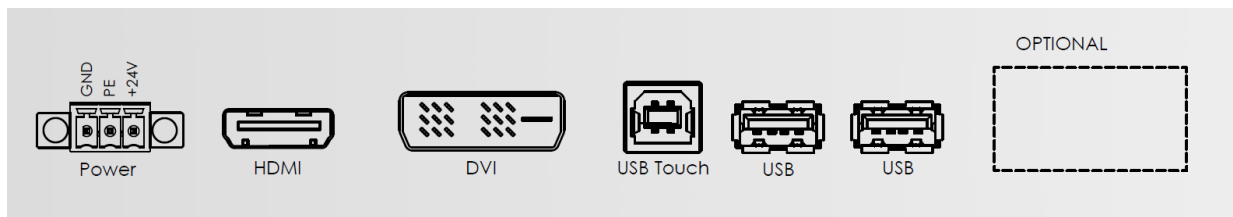

### INTERFACES

### MECHANICAL & ENVIRONMENTAL

<b>Housing Front</b>	Glass, Black Frame
<b>Housing</b>	Aluminium / Silver
<b>Dimensions</b>	266 mm x 213.2 mm x 52.4 mm
<b>Weight</b>	1.4 kg
<b>Cooling</b>	Passive
<b>Operating Temperature</b>	0 ~ 50 °C
<b>Storage Temperature</b>	-10 ~ 70 °C
<b>Humidity</b>	5 ~ 80% (non condensing)
<b>Protection Class</b>	IP65 (IP20 rear)
<b>Certification</b>	CE, EN55022, EN55024, DIN EN ISO 9001

# Touch-it Monitor Front Panel glass 10,4

## Datasheet

### DIMENSIONS

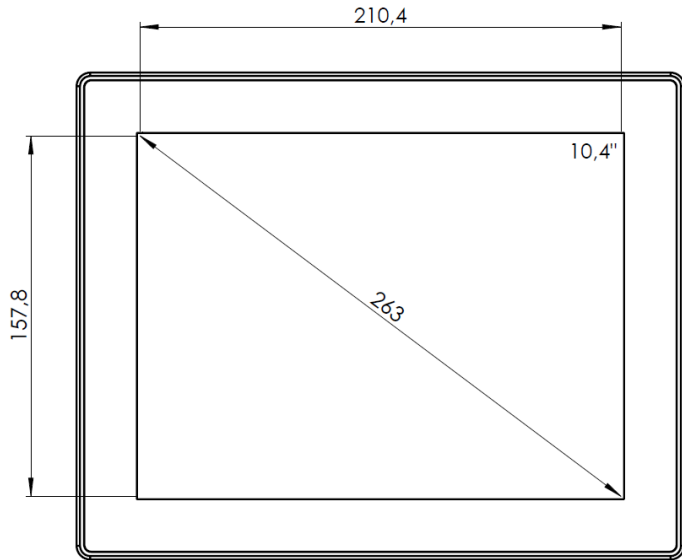

FRONT VIEW

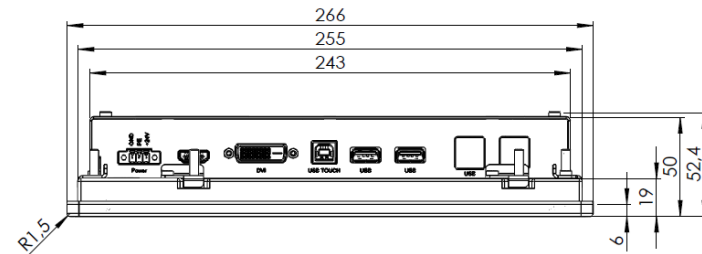
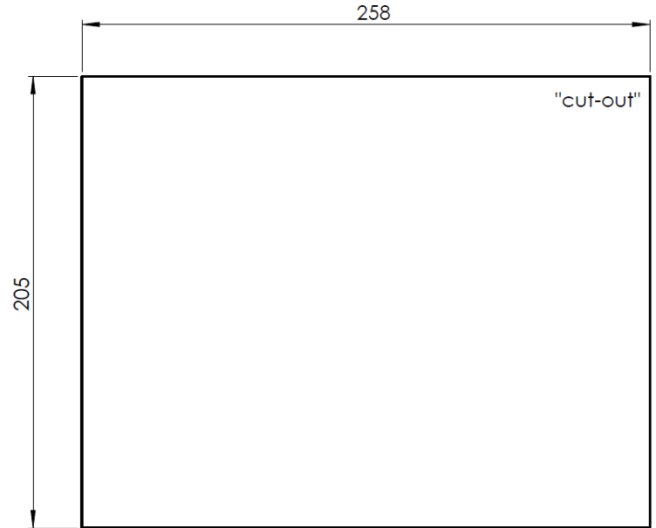

BOTTOM VIEW

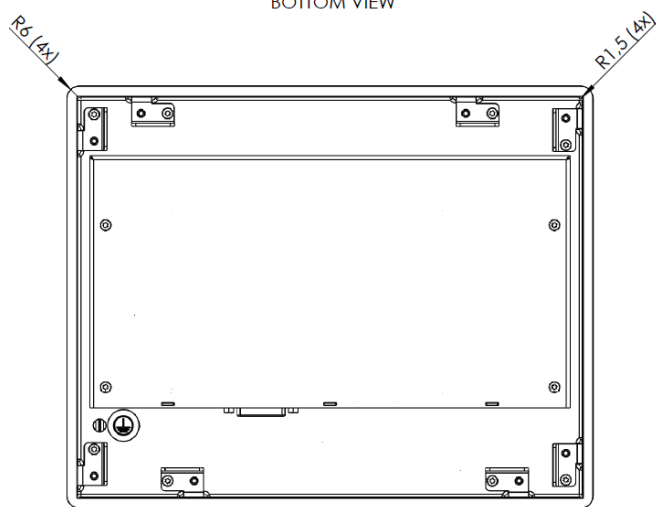

REAR VIEW

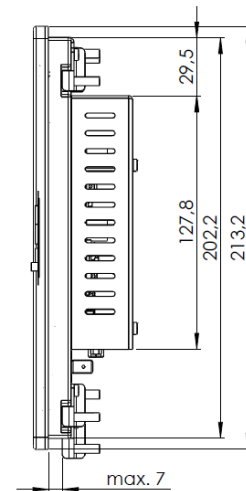

SIDE VIEW

# Touch-it Monitor Front Panel glass 10,4

## Datasheet

### ORDERING INFORMATION

Art. No.:	Display		Optional Interfaces
	800 x 600	1024 x 768	4 x USB
<b>E751009</b>	<input type="checkbox"/>	<input checked="" type="checkbox"/>	<input type="checkbox"/>

### DISCLAIMER

Technical data are subject to modification and delivery subject to availability. Any liability that the data and illustrations are complete, actual or correct is excluded. Designations may be trademarks and/or copyrights of the respective manufacturer, the use of which by third parties for their own purposes may infringe the rights of such owner.

**CHRIST ELECTRONIC SYSTEMS GMBH**  
**MANUFACTURE OF INDUSTRIAL ELECTRONICS**

### CONTACT

Christ Electronic Systems GmbH  
Alpenstraße 34  
87700 Memmingen  
Phone: +49 8331/ 83710  
[www.christ-es.de](http://www.christ-es.de)

### FROM IDEAS TO REALITY

We are a German developer and manufacture of innovative HMI-systems for demanding industrial applications. Christ offers an extensive range of

TOUCH PANEL PCs	x86 & ARM
TOUCH MONITORS	7" – 24"
SINGLE BOARD COMPUTER	Windows & Linux
VISUALISATION SYSTEMS	HMI & SCADA